



Pre-ignition Detection Followed by Immediate Damage Mitigation in a Spark-Ignited Engine

Item Type	Conference Paper
Authors	Singh, Eshan;Dibble, Robert W.
Citation	Singh, E., & Dibble, R. (2021). Pre-ignition Detection Followed by Immediate Damage Mitigation in a Spark-Ignited Engine. SAE Technical Paper Series. doi:10.4271/2021-01-0437
Eprint version	Post-print
DOI	10.4271/2021-01-0437
Publisher	SAE International
Rights	Archived with thanks to SAE International
Download date	2023-12-07 19:16:07
Link to Item	http://hdl.handle.net/10754/669100

Pre-ignition detection followed by immediate damage mitigation in a Spark-Ignited Engine.

Author, co-author (Do NOT enter this information. It will be pulled from participant tab in MyTechZone)

Affiliation (Do NOT enter this information. It will be pulled from participant tab in MyTechZone)

Abstract

Pre-ignition remains a significant bottleneck to further downsizing and downsizing technologies employed for reducing CO₂ emissions in modern turbocharged spark-ignited engines. Pre-ignition, which occurs rarely, may lead to high peak pressures that auto-ignite the entire charge before TDC. The resulting high-pressure oscillations are known as super-knock, leading to sudden and permanent hardware damage to the engine. Over the years, numerous researchers have investigated the stochastic phenomenon's source and concluded that there is a role of lubricant additives, deposits, gasoline properties, and hot surfaces in triggering pre-ignition. No single source has been identified; the research continues. Here, we take a different approach; rather than continue the search for the source(s) of super-knock, we explore mitigating super-knock by detecting pre-ignition early enough to take immediate evasive action. Such evasive action is expected to suppress knock intensity, thereby saving the engine from any permanent damage.

In this regard, the current work offers ways to detect pre-ignition (using ion sensors) and then mitigate engine damage by using immediate fuel enrichment. We present three related explorations.

In exploration #1, we explore if the occurrence of ions products from the exhaust can warn that the next cycle has a high probability of pre-ignition. For this next cycle, the intake fuel injection can be suspended or increased to operate engine fuel-rich. We find strong ion activity on every cycle. However, there is a weak correlation between the ion signal and pre-ignition occurrence.

In exploration #2, an in-cylinder ion-current sensor is used to discover pre-ignition event unfolding during the compression stroke. When such a rare event is detected, more fuel is immediately injected, making the end gas far less reactive and avoiding autoignition and knock. These explorations #1 and #2 were conducted with a DC-based ion sensor. These explorations showed exciting and promising findings. However, our DC-based ion sensors are prone to low signal-to-noise ratio SNR, leading to false positives (unacceptably high number of false positives.)

In Exploration #3, the signal-to-noise ratio improvement is explored by replacing the DC-based system with a novel AC-based system. We find the bandpass filtering of the ion signal is key to improved SNR.

Introduction:

Many kinds of combustion engines have been proposed over the last 200 years. The field is now reduced to two lead engine types, Compression Ignited (CI) and Spark Ignited (SI) engines. Climate

change legislations have encouraged less CO₂ emissions from all engines, necessitating improved engine efficiency (or a change to alternate fuels). The efficiency of spark-ignited engines is often limited by 'knock', which is the sudden and rapid auto-ignition of the fuel-in-air mixture (called 'end gas') ahead of the oncoming spark-initiated flame front [1]. A common goal is that the advancing flame front consumes the end gas before the end gas has had enough time to auto-ignite.

With pressure sensors in engine cylinders, one reveals that 'knock' is caused by the pressure oscillations in the cylinder. Auto-ignition of the fuel-air mixture in the end-gas zone of the cylinder creates pressure waves that propagate and are reflected, even being focused, by the curved cylinder walls. Such pressure fluctuations are more than an annoyance, but in fact, cause steady damage to in-cylinder parts.

With climate change legislation emerging, many car companies increasingly turn to make engines that emit less CO₂ by downsizing and downsizing while increasing the intake air pressure, 'boosting', to deliver the larger engines' peak power, when demanded. The increase in intake pressure increases the collision rate of molecules. Thus, it accelerates chemical reactions and unavoidably reduces the time needed for the end gas to arrive at auto-ignition time. Moreover, the lower speed of the engine invites problems by allowing more time for the end gas to reach the auto-ignition time. Detection of faults, like knock occurring due to auto-ignition or failure of engine components, becomes critical, not only for engine health but for continuous compliance of emission targets as well [2].

An additional problem is emerging, in rare cycles (say less than 1 in 10,000); combustion inside of the engine cylinder is increasingly occurring *before* the spark is initiated. These rare events are called 'pre-ignition'. No different from an advanced spark timing, a pre-ignition event predictably leads to higher peak pressure. Such extreme conditions accelerate the chemical reactions that lead to a reduced autoignition time, leading to end gas explosions before TDC. This creates exceptionally large pressures with attendant large pressure oscillations, termed as super-knock. It is widely accepted that a pre-ignition flame is caused by hot particles or hot spots or debris, which are artifacts from the previous combustion cycle. If, for some reason, a combustion event creates hot particles. It may be expected that these hot particles are discharged through the exhaust port. However, closer inspection indicates that some fraction of the exhaust is *not pushed out* of the chamber. This small fraction is called the *residual fraction*. There may be a few hot particles, or burning oil droplets, or hot spots that become blended with the incoming fuel-in-air during the intake stroke in the residual fraction. The hot particles or hot spots or burning oil droplets may grow into a flame that emerges well before the spark plug ignition; hence, we have created a *pre-ignition* event.

Historically, researchers have explored what is causing the pre-ignition event. The list of possible sources is extensive and includes variations in lubrication oil, gasoline properties, potential hot spots on the cylinder walls, and more [3]. Knowing these many sources, a long list of recommendations of fuel and lube oil specifications has emerged.

Here, we explore a different route. Instead of increased specification on gasoline and lube oils, with a view of suppressing pre-ignition events, we ask: can we instead tolerate a few pre-ignition events by detecting a pre-ignition event in progress and then rapidly taking evasive maneuvers that abort the pre-ignition event right away?

For pre-ignition detection, pressure sensors have been essential for research but are usually considered too expensive for widespread mass production, commercial use (for a possible exception, see the Mazda’s SkyActiv-X engine [4]). As one alternative to a pressure sensors, data-driven algorithms have also been used to diagnose pre-ignition recently (2020) [5]. As an affordable surrogate for pressure sensor, many researchers have explored using ion sensors [6, 7]. The use of an ion current sensor is not novel by any measure. The earliest patents on its use in internal combustion engines date back to the 1890s [8, 9]. Downs (1950) used a pre-igniter (a hotspot with controllable heat energy) and an ion sensor to detect if pre-ignition occurred for a given heat energy [10, 11]. Melby (1953) used as many as 17 ion sensors on the cylinder head to track a pre-ignition event’s flame front propagation [12]. Ion sensors were employed in combustion diagnostics (to detect knock and combustion phasing) by several researchers [13, 14]. More recently, ion sensors are being investigated again for pre-ignition detection [15-18]. Using such a device to detect a pre-ignition event requires no additional hardware as the existing spark plug can be used as an ion current sensor when not sparking.

Current research explores three routes for pre-ignition detection and subsequent mitigation strategies.

Exploration #1, our first approach is to explore the products discharged during the exhaust stroke to see if, from time to time, an unusual amount of hydrocarbons or ions or particles are in an exhaust event. We then will explore if these unusual amounts of exhaust ion activity are precursors to pre-ignition in the next cycle. Here, pre-ignition detection is explored using a DC-based ion current sensor located in the exhaust. If we see such an unusual exhaust event, and if we learn that this event warns that the next cycle will have a pre-ignition event, then there is *plenty* of time for corrective action, including simply not injecting *any* fuel in the subsequent intake stroke or running the next cycle fuel-rich.

This first exploration #1 is motivated by Haenel *et al.* (2017) [19]. The researchers detected rare events of unburned hydrocarbon emissions during the exhaust cycle before a pre-ignition cycle. This exhaust detection may allow predicting a pre-ignition event in the following cycle, therefore giving ample time for evasive action. Instead of a hydrocarbon detector used by Haenel *et al.* (2017) [19], we explore using an ion detection.

Exploration #2, in our second approach, we use an in-cylinder ion current signal to alert that a pre-ignition flame has been initiated and is in progress. When alerted, we can immediately inject extra fuel.

A flame is reasonably described as a thin zone (~1mm) of intense chemical reaction that propagates and convects (at ~1mm/ms) through the combustion mixture inside the engine cylinder. Among the many chemical reactions inside the flame zone, are a few reactions that produce positive ions and electrons. These ions and electrons make the flame zone a mild plasma that can conduct electrical current. As the flame zone passes between charged electrodes (e.g., spark plug gap), an ion current flows for about 1 ms. A flame arrival is indicated when the ion current rapidly increases. A threshold level is set such that when the ion current exceeds the threshold, we say a (pre-ignition) flame has crossed the ion sensor gap (e.g., the spark plug gap).

In principle, we find this pre-ignition detection device works. In practice, the noise in the circuit produces some false positive detections of flame arrival. We need a system with higher SNR. A pioneering improvement in ion detection SNR was reported (2000) by Wilstermann *et al.* [20]. They upgraded the gap voltage from DC to AC with an associated AC detection circuit. While there is a wealth of research on DC-based ion current sensor, research on employing an AC-based ion current sensor is scant.

Exploration #3, our third approach is to propose an ion sensor where our DC system is upgraded to an AC system. Exploration #3 is basically Exploration #2, where we replace the DC system with a novel AC-based ion current circuit with a narrow bandpass filter detector.

Methodology:

This study uses a single-cylinder engine from AVL. The engine has several modifications to accommodate high peak pressures often encountered in a pre-ignition event, including a reinforced piston, and connecting rod. The engine consists of two intake and two exhaust valves, and centrally mounted spark plug, and direct injectors. While there is a side-mounted direct-injector available, only the central injector was used for supplying fuel at 150 bar injection pressure after being conditioned at 25°C. More details on the hardware can be found in [21]. Table 1 provides general specification of the AVL engine. Coryton Gasoline, a Euro V standard gasoline with RON 95, was the fuel for the current study. Detailed specifications and properties of the fuel can be found in [22]. A commercial SAE 5W30 lubricant oil was used for the experiments. There are pressure sensors in the intake and the exhaust manifold. The high-frequency in-cylinder pressure sensor is AVL GU22CK piezoelectric sensor, with a frequency response greater than 20,000 Hz, which we read every 0.1 CAD.

Table 1: Specifications for the AVL engine used for pre-ignition study.

Engine	AVL Single Cylinder
Displacement Volume	454 cc
Stroke	86
Bore	82
Connecting Rod	114
Compression Ratio	9.5:1
Valvetrain	4 valve – DOHC
Cylinder head	Pent roof

In this study, an ion-current sensor was used to detect ion activity, which would apprise imminent pre-ignition events. This would allow

an evasive action to be triggered to mitigate engine damage, sometimes observed in a pre-ignition cycle.

Experiments were conducted at an engine speed of 1200 rpm; coolant temperature was fixed at 80°C; intake air temperature and pressure were 25°C and 1 atm respectively. Ion current sensors can be repurposed spark plugs. However, two holes in the engine head were small in diameter, requiring us to make our ion detectors. Our custom-made ion detectors are insulated metal rods (d~1mm) that protrudes into the cylinder head, using the port that was previously occupied by a glow plug or side fuel injector.

Figure 1 shows a simplified circuit diagram for the DC or AC voltage supplied ion sensors used in these explorations. For the DC voltage ion

current sensor, a DC power supply of 90V was provided, and resistors are 500 kOhm. The AC voltage is also 90 volts.

In case of a pre-ignition event, flame front ions in the spark gap complete the circuit, leading to current flow with a concomitant voltage across the resistor. The voltage is easily seen on an oscilloscope and detected by electronics that detect a signal that is larger than a predetermined threshold. The same principle applies for an AC-based ion sensor, except that the source voltage is an alternating current at 10 kHz. Further details of the AC powered ion current sensor are provided later in the Results and Discussion section. One approach to aborting the combustion cycle is to open the exhaust valve. So far, this action is beyond us. Instead, we explore the immediate abortion of the combustion event by injecting more (too much) fuel into the chamber.

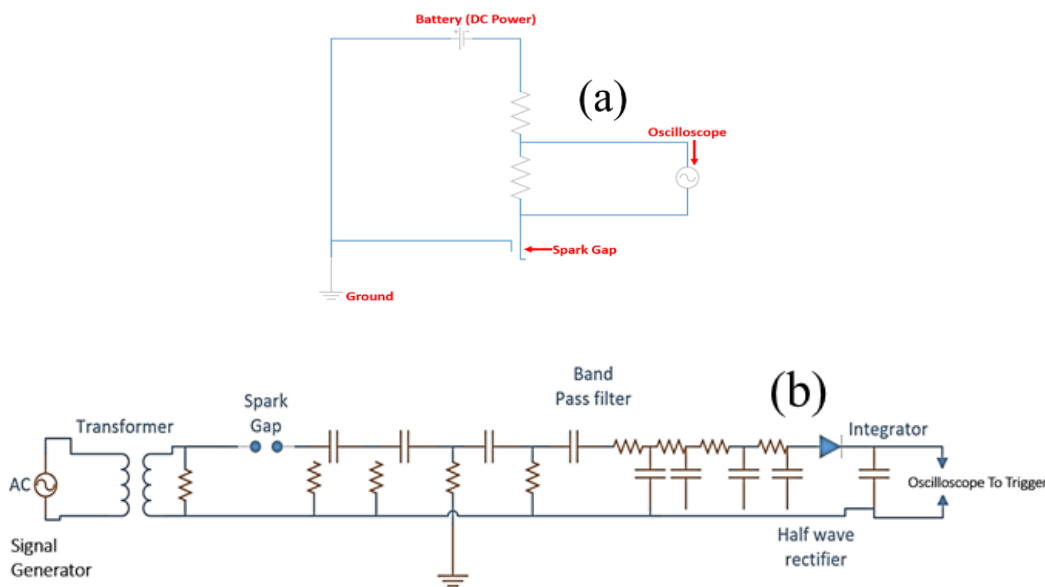

Figure 1: Circuit diagram for ion sensing (a) DC powered ion current (b) AC powered ion current circuit with an 8 order bandpass filter (at 10kHz) followed by rectifier followed by an integrator.

Results and Discussions:

Exploration #1: Pre-ignition prediction from exhaust cycle ion signal and mitigation strategy

In previous work, we direct-injected water late in the exhaust stroke to cool/quench only the residual exhaust without impacting the fresh incoming mixture (by finishing water injection before intake valve opening time) [23, 24]. Such strategy significantly suppressed pre-ignition frequency, supporting the idea that reactive debris in the residual gas is the cause for triggering pre-ignition in the subsequent cycle. This idea gained support from experiments that varied the amount of residuals in the engine by varying the exhaust back-pressure, and found pre-ignition frequency correlate with mass of residual fraction. The pre-ignition frequency followed the residual mass fraction in such experiments, as well [25]. Other researchers have shown that time-resolved detection of unusually high hydrocarbon emissions during the exhaust stroke indicates unusually high

hydrocarbon content in the residual gases that may trigger a pre-ignition event in the next cycle [19, 26, 27]. These time-resolved exhaust measurements were made using fast sampling hydrocarbon analyzers (called “Fast FID” by some). We propose using an inexpensive ion-current sensor in detecting unusual exhaust activity. Instead of looking for hydrocarbons, we will look for ions. We modified a spark plug merely by welding extensions to the electrodes, to detect exhaust ions better. The modified spark plug and its location are shown in Figure 2, along with the ion current signal (in blue), pressure signal (in black), and exhaust valve lift profile (red). Ion current is observed at the instant of exhaust valve opening (EVO). The signals are highly repeatable and observed in every cycle. Unfortunately, the signals do not correlate with the hydrocarbon emissions in the exhaust. This was confirmed by operating the engine at three different lambdas, resulting in different exhaust hydrocarbon emissions, measured by a fast-FID. The ion current signal showed no correlation with the HC emissions in the exhaust (data shown in Appendix). Moreover, it was found that all types of pre-ignition events did not have a high hydrocarbon warning [28].

When some unusual exhaust ion activity is detected in the exhaust stream, hinting at an imminent pre-ignition event in the next cycle, we may inject more fuel (operating rich) during the intake stroke. We investigated this fuel richness route for its knock suppression potential. All fuel was injected at SoI of -300 CAD aTDC. Figure 3 shows the effect of operating the cycle rich on knock intensity (KI). KI increases initially at slightly rich conditions and decreases after more fuel is injected ($\lambda < 0.65$). Previous researchers have observed similar behaviour for ethanol [29]. At low fuel enrichment levels, increasing fuel quantity reduces the auto-ignition delay time and increases the probability of auto-ignition in the end gas. This is investigated further using chemical kinetic simulations next.

Chemical kinetic simulations were performed to help us better understand this behaviour of auto-ignition time vs. fuel enrichment. A closed homogeneous constant volume batch reactor model was used in ChemKin [30] using a well-validated mechanism from Sarathy *et al.* [31]. A multi-component FACE G fuel surrogate to mimic ignition behavior of Euro V Coryton gasoline used in the current study to match the RON of the fuel. Details of the surrogate fuel composition can be found in [32]. A constant initial pressure (25 atm) and initial temperature (700-1000 K) are imposed, and λ is varied from rich to lean, 0.5 to 1.7. The temperature and equivalence ratio sweep are done to simulate the charge cooling and chemical reactivity with enrichment fuel addition. With decreasing λ , auto-ignition time is decreased. However, decreasing temperature increases gasoline's auto-ignition delay time (except for negative temperature coefficient (NTC) regime of 750-900 K). Operating the engine rich leads to temperature and λ decrease (as shown by arrow in figure 4). The two competing effects help in explaining the KI trend observed in Figure 3.

Exploration #2: Same cycle in-cylinder pre-ignition detection using DC-based ion current sensor followed by mitigation strategy

In Exploration #2, an ion sensor was mounted inside the cylinder, on the head, to detect pre-ignition in the combustion chamber. The glowplug and side-mounted injector are removed, and customized spark plugs are made in-house to fit the two locations shown in Figure 5. The ground electrode for the two in-house spark plugs is the engine head block. One of the three locations is used as a *fake* pre-ignition location, and one is used as an ion current sensor. In the following text, the locations of the central spark plug, glow plug and side-mounted direct injector, that now house a spark plug or ion sensor, will be referred to as SP, GP and SM respectively.

When the mixture is ignited at one plug, the newly created flame takes time to arrive at the ion detectors. This flame travel time, called detection delay time, is slightly different for different combinations of spark plug and ion detection. From the cylinder pressure, one can compute a *mass fraction burned* (MFB) at the time of detection. The result of these computations is shown in Table 2. The results from the pre-ignition spark at SM location are not reported as the ignition was unreliable due to unstable combustion and frequent misfires. Table 2 shows that earlier detection occurs when the spark plug, and ion sensor are closely coupled. For cases when pre-ignition initiates far from the sensor, the detection delay time is longer. In figure 9-14 of [1], the flame front has traversed a large part of the cylinder when only a small fraction of fuel-air charge has burned. This is due to a significant

expansion of the burnt mixture compared to the unburnt charge. This means that the flame has already occupied a large fraction of volume if pre-ignition detection occurs at a high MFB (>10%).

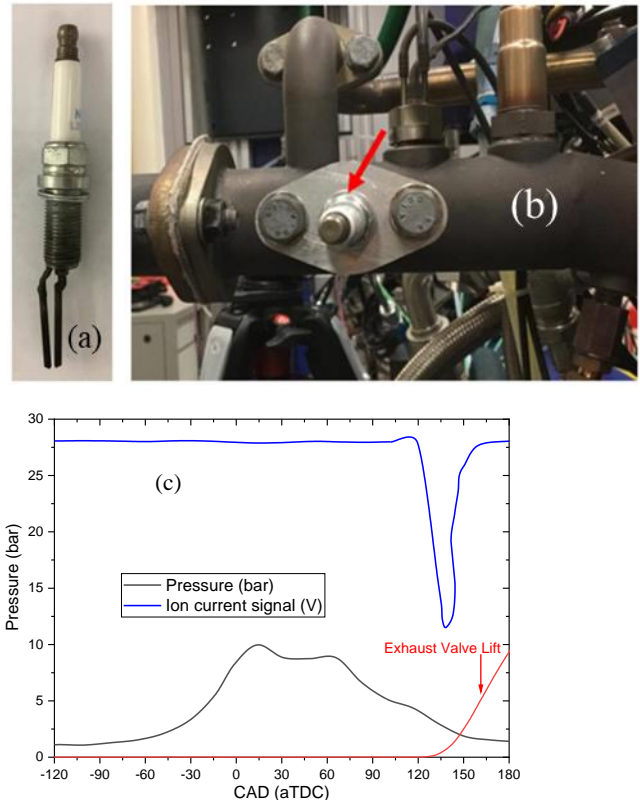

Figure 2: (a) forking spark plug is ion sensor, (b) location of spark plug in the exhaust, (c) ion current signal from the exhaust manifold (blue), pressure signal (black) and exhaust valve lift profile (red).

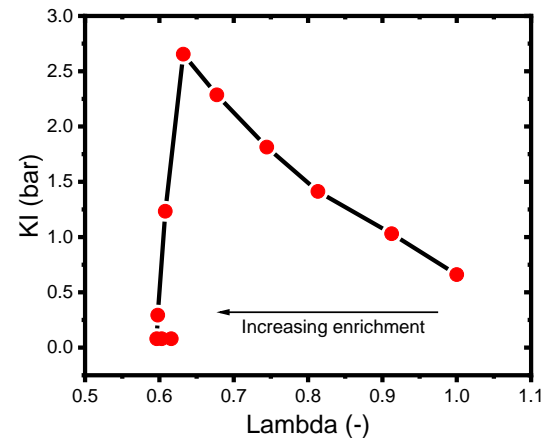

Figure 3. Effect of fuel enrichment on knock intensity. When a pre-ignition event is detected, the fuel needs to be nearly doubled.

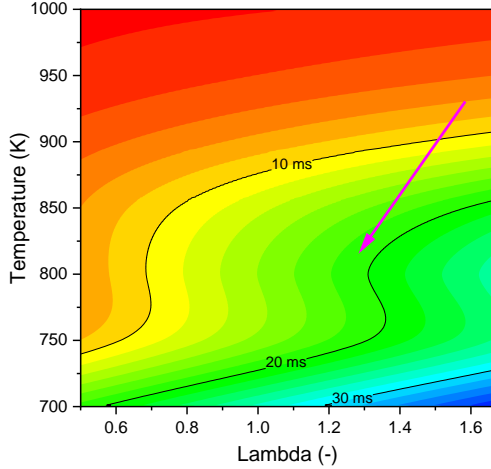

Figure 4: Auto-ignition delay times calculated for a homogeneous constant volume batch reactor for surrogate fuel. With decreasing lambda, ignition delay time decreases, leading to more knock intensity. Decreasing temperature leads to an increase in ignition delay time (except in the NTC regime), leading to lower knock intensity. The simulations support the observed experimental trends.

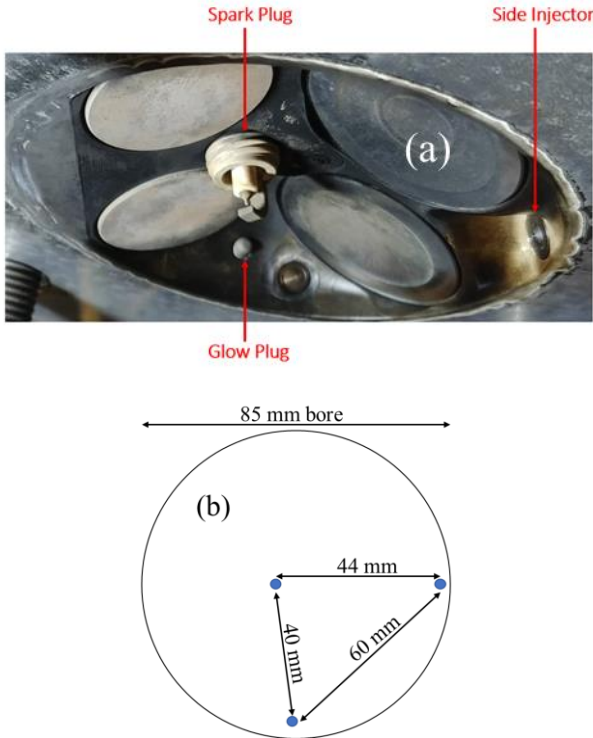

Figure 5: (a) In-house spark plugs were made to fit the glowplug (GP) and Side-mounted Injector (SM), while the default spark plug was used at the central location (SP). (b) relative location of SP, GP and SM in the cylinder head are shown for reference.

Table 2: Effect of different locations of pre-ignition source and detection unit on the detection delay time.

Location of Pre-ignition	Location of Ion sensor	Mass fraction burned pressure (% MFB)	Detection delay time (ms)
GP	SP	8.7	3.5
GP	SM	39.0	6.1
SP	GP	10.9	2.2
SP	SM	7.6	2.2

When a pre-ignition event is detected during the compression stroke, we seek a counter-strategy that avoids damage from a potential super-knock event. Fuel enrichment was again explored as one such evasive strategy. Fake pre-ignition events were conducted with advanced spark timing (-17 CAD aTDC), and then enrichment fuel was injected with varying delay after the fake pre-ignition. A delay of 0 ms (black data in figure 6) means the spark and injection timings were both at -17 CAD aTDC. This corresponds to an ideal scenario where there is no delay between pre-ignition detection and evasive action. We find that the KI decreases monotonically with an increasing amount of enrichment fuel, as opposed to the previous case (see Figure 3). For a more realistic scenario, the injection of enrichment fuel was delayed relative to the advanced spark timing that simulates a pre-ignition event. For a detection delay time of 1 ms (red data in figure 6) and 2.4 ms (blue data in figure 6), the KI trend remains the same. At 1200 RPM, each 2.4 ms is about 15 degrees. It is remarkable that even injecting very near TDC can still reduce KI.

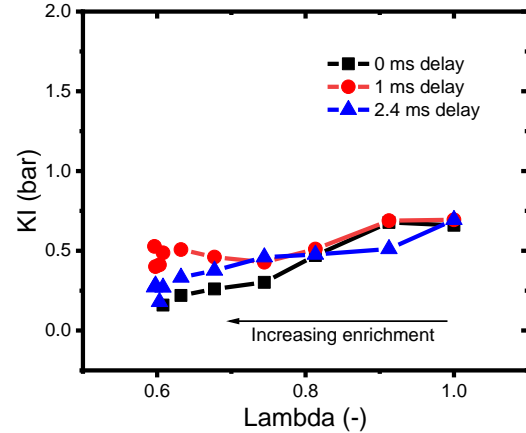

Figure 6: Effect of enrichment duration on knock intensity. Case 2: An advanced combustion event is detected, and enrichment fuel is injected into the already started flame. Spark timing of -17 is used, and enrichment fuel is injected with a delay ranging from 0 to 2.4 ms. It is remarkable that even with the long delay, fuel injection still reduces KI

Exploration #3: AC-voltage based ion current sensor

The DC voltage ion current sensors suffer from low signal-to-noise ratio SNR [13, 14]. As noted earlier, with low SNR, a false ion signal from noise, instead of a flame front passing the ion sensor gap, may be detected. Such *false positives* will be less with larger SNR. An improvement in SNR is anticipated if the signal can become an AC signal rather than a DC signal. In this regard, a novel AC voltage powered ion current sensor was devised. As shown in the circuit diagram in Figure 1b, a signal generator produces a $f = 10$ kHz

alternating voltage at 9V, which goes through a 10X transformer to the ion sensor’s open gap. In case of a pre-ignition event, ions in the traversing flame front temporarily close the circuit. The choice of frequency $f = 10 \text{ kHz}$ was expedient. As we shall see below, even higher frequencies could be explored.

The sequence of AC signal processing is shown in figure 7.

Initially, a digital lock-in amplifier (Stanford Research Systems SR810) was used to isolate the ion signal carried at 10 kHz. The lock-in output signal-to-noise ratio was excellent, leading to zero false-positive events. However, the vast internal computation required a delay of $\sim 2 \text{ ms}$ between when the flame arrived at the ion detector and when an abort trigger signal was launched from the digital lock-in amplifier. This delay of 2 ms is potentially too long as it may allow the pre-ignition event to become a super-knock event. Reluctantly, the digital filter is replaced with an analog bandpass filter, centered around 10 kHz range with 8th order bandpass filter (see figure 7a). The unfiltered signal (black line) has a voltage across the frequency range, while the filtered signal (red line) has a peak centred around 10 kHz frequency. Note that the bandpass filter rejects a great deal of noise.

After the signal easily passes the bandpass filter, we rectify the signal with a $\frac{1}{2}$ wave device (a full-wave rectifier would be even better), producing the series of *half-waves* shown in the top of Fig 7b. Figure 7c illustrates a step function model of the flame zone, passing the detector electrodes. The 10 kHz signal will be ON for several ms. As these half waves are integrated, we see the rapidly growing integral in the middle of Fig. 7c. For illustration, we show the integral exceeding the trigger threshold at 250 μs (also shown is the integral output from the digital lock-in amplifier, which has an unacceptably long *internal* delay time of 2,000 μs). The trigger pulse is sent to the fuel injector driver, which to our pleasant surprise, has an internal delay (from the time a signal is given to inject to the actual start of injection) of 100 μs . We report a total delay of $100 + 250 = 350 \text{ } \mu\text{s}$. Figure 6 shows that injecting as late as 2.4 ms (2400 μs) is *still* effective at reducing knock intensity. Our technology (at 350 μs) is acceptable for knock suppression and thus super knock suppression.

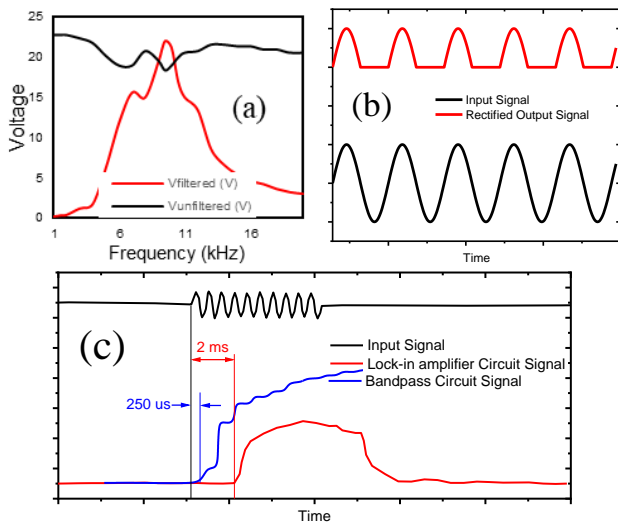

Figure 7: (a) The unfiltered output signal undergoes a bandpass filtering reducing the noise from frequencies other than the carrier frequency of 10kHz. (b) The filtered signal goes through the half-wave rectified and (c) integrator circuit. A trigger is placed on the rising signal from the integrator circuit (there is a delay of 2 ms using a lock-in amplifier, which is reduced to 250 μs when using a bandpass filter).

Combining the two, pre-ignition detection and evasive strategy, will lead to reliable technology that protects any SI engine from deleterious hardware damage irrespective of lube oil or gasoline [34]. The current study was conducted at a fixed engine speed of 1200 rpm. This provides $\sim 50 \text{ ms}$ time in each cycle. This is a relatively low speed, allowing time for detection and mitigation of a pre-ignition event. The allowed time will decrease as engine speed increases. However, pre-ignition is known to occur less and less frequently as engine speed increases.

As part of this discussion, we here explore why the SNR of the AC device improved over the SNR of the DC device. We find the best source of information is simply studying how AM radio works. Our AC system’s improvement came merely from using an ‘8th order’ narrow bandpass filter for the AC signal processing while no intentional bandpass filter was used with the DC single processing. For discussion, we assume the flame zone, aka the ion zone, is 1 mm thick and moves at about $1 \text{ m/s} = 1 \text{ mm/ms}$. As the flame zone passes the electrodes, we generate a single ‘square wave’ with a width of $\sim 1 \text{ ms}$, and thus the strongest sine wave component is at $f \sim 1000 \text{ Hz}$ and rapidly decreasing amplitudes for higher harmonics. Thus, had we put a narrow bandpass filter centered at 1 kHz, with bandwidth the same as our 10 kHz bandpass filter, then, we would have, in retrospect, accomplished about the same SNR improvement. Having no intentional filtering, the previous DC systems have an unnecessarily wide bandpass and thus accept too much noise along with the signal and thus a low SNR.

Conclusions:

The present work proposes a novel ion current sensing method for detecting pre-ignition events and investigates fuel enrichment as an evasive method to avert super-knock and avoid engine damage.

We find exhaust is rich in ions in every exhaust event. However, no positive (or negative) correlation was observed between the exhaust ion concentration in one cycle and pre-ignition in the next cycle, as confirmed in [28].

The ion sensor inside the cylinder head easily detects the fake pre-ignition-initiated-flame. With our early detection, we find that there is enough time to trigger the in-cylinder fuel injector to immediately add more fuel, which cools the charge and changes the chemistry, suppressing the probability of end-gas auto-ignition.

A novel AC-based ion current sensor is proposed with the potential to reduce the signal-to-noise ratio and achieve earlier detection of incipient pre-ignition event. We find that the 8th order bandpass filter is the main reason for this AC based device’s success.

Acknowledgment:

The research reported in this article was funded by Saudi Aramco under the aegis of FuelCom 2. The authors thank Adrian Ichim and Riyadh Jambi for their help in setting up the engine.

References:

- [1] J. B. Heywood, *Internal combustion engine fundamentals*. McGraw-hill New York, 1988.
- [2] S. R. Dadam, R. Jentz, and H. Meissner, "Diagnostic Evaluation of Exhaust Gas Recirculation (EGR) System on Gasoline Electric Hybrid Vehicle," SAE Technical Paper 2020-01-0902, 2020.
- [3] E. Singh, M. J. M. Ali, A. Ichim, K. Morganti, and R. Dibble, "Effect of Mixture Formation and Injection Strategies on Stochastic Pre-Ignition," SAE Technical Paper 2018-01-1678, 2018.
- [4] M. Hitomi, T. Hayashi, K. Sumida, M. Yamakawa, S. Matsuzaki, and H. Maeda, "Control device for spark-ignition engine," ed: Google Patents, 2005.
- [5] N. Kuzhagaliyeva, A. Thabet, E. Singh, B. Ghanem, and S. M. Sarathy, "Using deep neural networks to diagnose engine pre-ignition," *Proceedings of the Combustion Institute*, 2020.
- [6] G. Bogin Jr, J.-Y. Chen, and R. W. Dibble, "The effects of intake pressure, fuel concentration, and bias voltage on the detection of ions in a Homogeneous Charge Compression Ignition (HCCI) engine," *Proceedings of the Combustion Institute*, vol. 32, no. 2, pp. 2877-2884, 2009.
- [7] N. A. Henein, W. Bryzik, A. Abdel-Rehim, and A. Gupta, "Characteristics of ion current signals in compression ignition and spark ignition engines," *SAE International Journal of Engines*, vol. 3, no. 1, pp. 260-281, 2010.
- [8] E. J. Stoddard, "Electrical igniter for gas-engines," ed: Google Patents, 1902.
- [9] F. R. McMullin, "Electric spark for gas-engines," ed: Google Patents, 1901.
- [10] D. Downs and J. Pigneguy, "An experimental investigation into pre-ignition in the spark-ignition engine," *Proceedings of the Institution of Mechanical Engineers: Automobile Division*, vol. 4, no. 1, pp. 125-149, 1950.
- [11] D. Downs and F. Theobald, "The effect of fuel characteristics and engine operating conditions on pre-ignition," *Proceedings of the Institution of Mechanical Engineers: Automobile Division*, vol. 178, no. 1, pp. 89-108, 1963.
- [12] A. Melby, D. Diggs, and B. Sturgis, "An investigation of preignition in engines," SAE Technical Paper, 1954.
- [13] R. Butt, Y. Chen, J. Mack, S. Saxena, R. Dibble, and J.-Y. Chen, "Improving ion current of sparkplug ion sensors in HCCI combustion using sodium, potassium, and cesium acetates: Experimental and numerical modeling," *Proceedings of the combustion institute*, vol. 35, no. 3, pp. 3107-3115, 2015.
- [14] S. Saxena, J. Chen, and R. Dibble, "Increasing the signal-to-noise ratio of sparkplug ion sensors through the addition of a potassium acetate fuel additive," *Proceedings of the Combustion Institute*, vol. 33, no. 2, pp. 3081-3088, 2011.
- [15] S. Tong, Z. Yang, X. He, J. Deng, Z. Wu, and L. Li, "Knock and pre-ignition detection using ion current signal on a boosted gasoline engine," SAE Technical Paper 2017-01-0792, 2017.
- [16] J. Wang *et al.*, "In Cycle Pre-Ignition Diagnosis and Super-Knock Suppression by Employing Ion Current in a GDI Boosted Engine," SAE Technical Paper 2020-01-1148, 2020.
- [17] K. Kumano, Y. Akagi, S. Matohara, Y. Uchise, and Y. Yamasaki, "Using an ion-current sensor integrated in the ignition system to detect precursory phenomenon of pre-ignition in gasoline engines," *Applied Energy*, vol. 275, p. 115341, 2020.
- [18] N. Cavina, N. Rojo, L. Poggio, L. Calogero, and R. Cevolani, "Investigation on pre-ignition combustion events and development of diagnostic solutions based on ion current signals," *SAE International Journal of Engines*, vol. 10, no. 4, pp. 1518-1523, 2017.
- [19] P. Haenel, H. Kleeberg, R. de Bruijn, and D. Tomazic, "Influence of Ethanol Blends on Low Speed Pre-Ignition in Turbocharged, Direct-Injection Gasoline Engines," *SAE International Journal of Fuels and Lubricants*, vol. 10, no. 2017-01-0687, pp. 95-105, 2017.
- [20] H. Wilstermann, A. Greiner, P. Hohner, R. Kemmler, R. Maly, and J. Schenk, "Ignition system integrated AC ion current sensing for robust and reliable online engine control," SAE Technical Paper 2000-01-0553, 2000.
- [21] E. Singh, K. Morganti, and R. Dibble, "Knock and Pre-Ignition Limits on Utilization of Ethanol in Octane-on-Demand Concept," SAE Technical Paper 2019-24-0108, 2019.
- [22] E. Singh, Morganti, K., Dibble, R. W., "Dual-fuel operation of Gasoline and Natural Gas in a Turbocharged Engine.," *FUEL*, 2018.
- [23] E. Singh, P. Hlaing, and R. W. Dibble, "Investigating Water Injection in Single-Cylinder Gasoline Spark-Ignited Engines at Fixed Speed," *Energy & Fuels*, 2020.
- [24] E. Singh, P. Hlaing, H. Shi, and R. Dibble, "Effect of Different Fluids on Injection Strategies to Suppress Pre-Ignition," SAE Technical Paper 2019-01-0257, 2019.
- [25] E. Singh and R. Dibble, "Mechanism triggering pre-ignition in turbo-charged engines," SAE Technical Paper 2019-01-0255, 2019.
- [26] E. Singh and R. Dibble, "Effectiveness of Fuel Enrichment on Knock Suppression in a Gasoline Spark-Ignited Engine," SAE Technical Paper 2018-01-1665, 2018.
- [27] M. Khosravi, H. Ruhland, T. Lorenz, and C. Weber, "Investigation into Occurrence of Megaknock and Auto-Ignition in GTDI Engines," SAE Technical Paper 2017-01-0690, 2017.
- [28] V. S. Costanzo, X. Yu, E. Chapman, R. Davis, and P. Haenel, "Fuel & Lubricant Effects on Stochastic Preignition," SAE International Journal of Advances and Current Practices in Mobility, vol. 1, no. 2019-01-0038, pp. 259-277, 2019.
- [29] A. Cairns and M. M. Koupaie, "The Competing Chemical and Physical Effects of Transient Fuel Enrichment During Heavy Knock in an Optical SI Engine Using Ethanol Blends," SAE Technical Paper 2017-01-0665, 2017.
- [30] R. Design, "CHEMKIN-PRO," ed: Reaction Design San Diego, CA, 2008.
- [31] S. M. Sarathy *et al.*, "Compositional effects on the ignition of FACE gasolines," *Combustion and Flame*, vol. 169, pp. 171-193, 2016.
- [32] E. Singh and R. Dibble, "Knock, Auto-Ignition and Pre-Ignition Tendency of Fuels for Advanced Combustion Engines (FACE) with Ethanol Blends and Similar RON," SAE Technical Paper 2020-01-0613, 2020.

Contact Information

Eshan Singh
Clean Combustion Research Centre
King Abdullah University of Science and Technology
Thuwal, Saudi Arabia

Definitions/Abbreviations

aTDC	After top dead center
CAD	Crank angle degrees
DOHC	Direct overhead cam
GHG	Greenhouse Gases

IDT	Ignition Delay Time
IMEP	Indicated Mean Effective Pressure
NTC	Negative Temperature Coefficient
SNR	Signal-to-Noise Ratio
RON	Research Octane Number
rpm	Rotations per minute
SI	Spark Ignition
KI	Knock Intensity
DC	Direct Current
AC	Alternating Current

Appendix:

Experiments were done to investigate any correlation between the highly reliable time-resolved signal seen in the exhaust ion sensor and time-resolved hydrocarbon emissions. A fast-Flame Ionization Detector (fast-FID) sampling probe was placed near the exhaust valve providing crank-angle and cycle resolved hydrocarbon emissions. Ion current signals were monitored simultaneously. The following figure shows the results over several cycles recorded at three different lambdas. Three lambda values were chosen to force a different hydrocarbon emission range from the engine (hydrocarbon emissions increase with decreasing lambda). The expectation was that the ion current signal might show a monotonic relation with the hydrocarbon measured in the exhaust. The figure shows peak HC emission from each cycle plotted versus peak ion signal in the exhaust cycle.

